

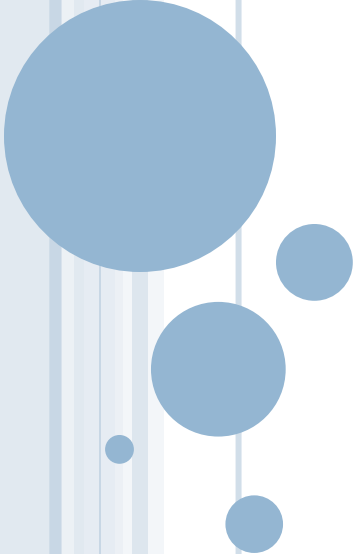

CATALOG

Garde
corps

www.noblesse-company.com



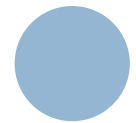
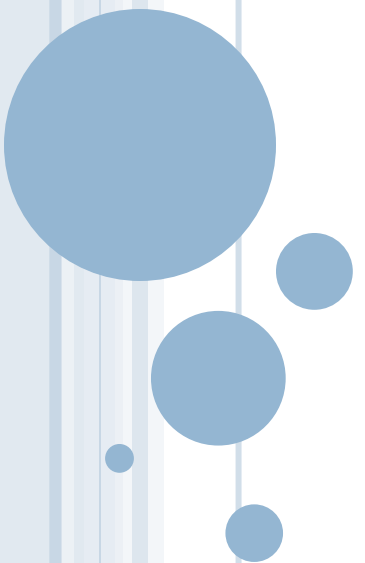



PESPA 001
TUBULAR KIT Ø40 CORNER 45°

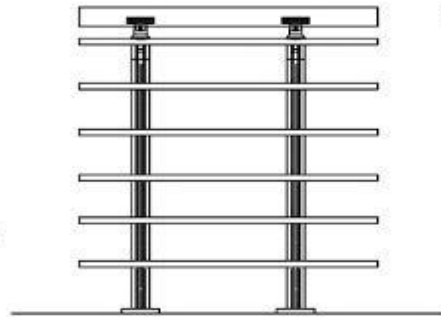

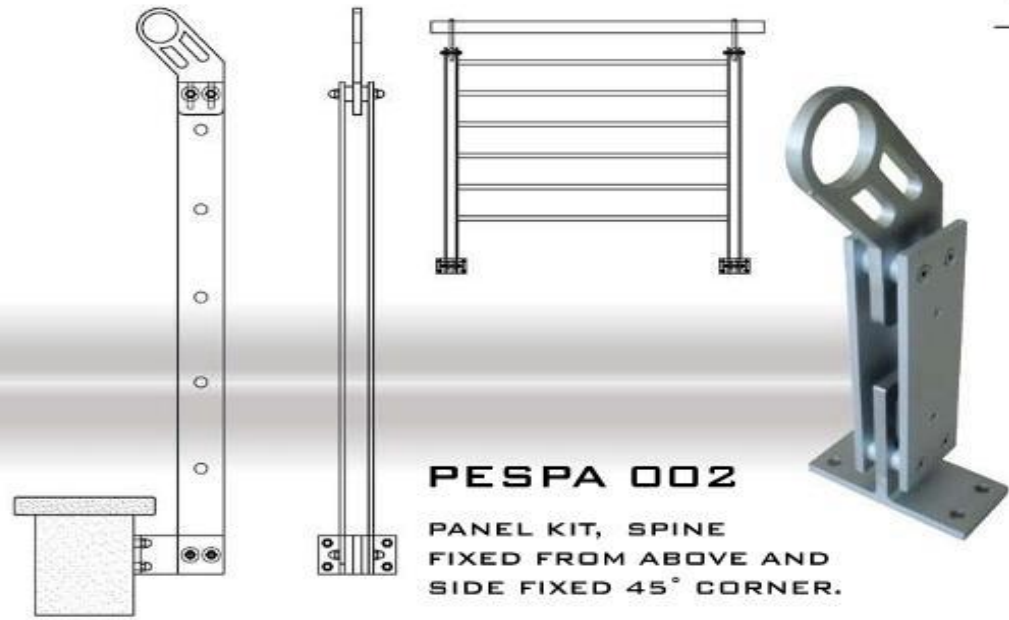

PESPA 002
PANEL KIT, SPINE
FIXED FROM ABOVE AND
SIDE FIXED 45° CORNER.





PESPA 003

TUBULAR KIT, $\varnothing 40$ AND PANEL
FIXED FROM ABOVE AND
SIDE FIXED

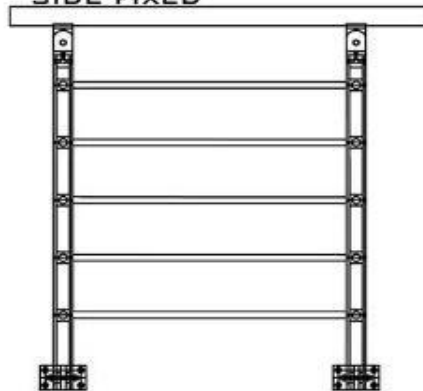

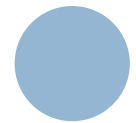
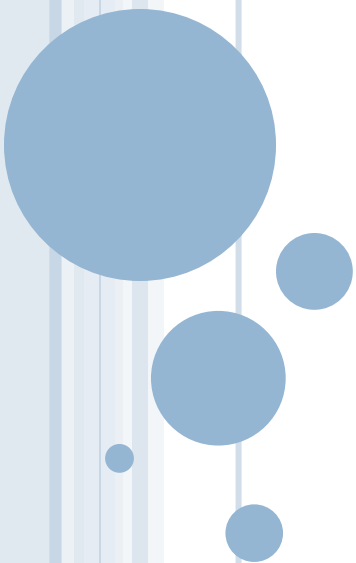
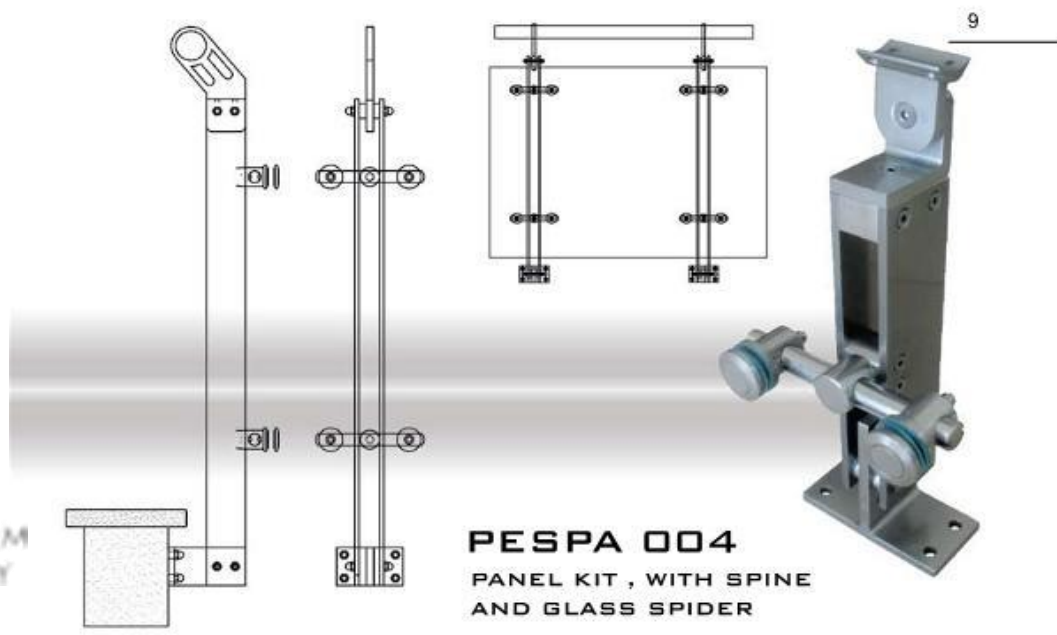



PESPA 005
VERTICAL GLASS WALL

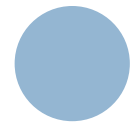
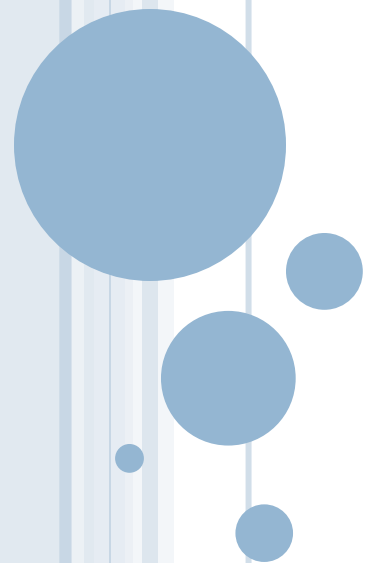



PESPA 006
HORIZONTAL GLASS WALL

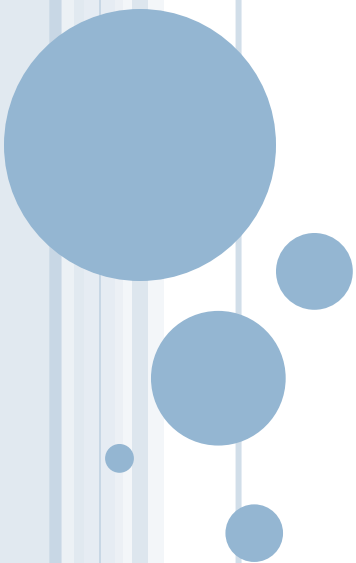
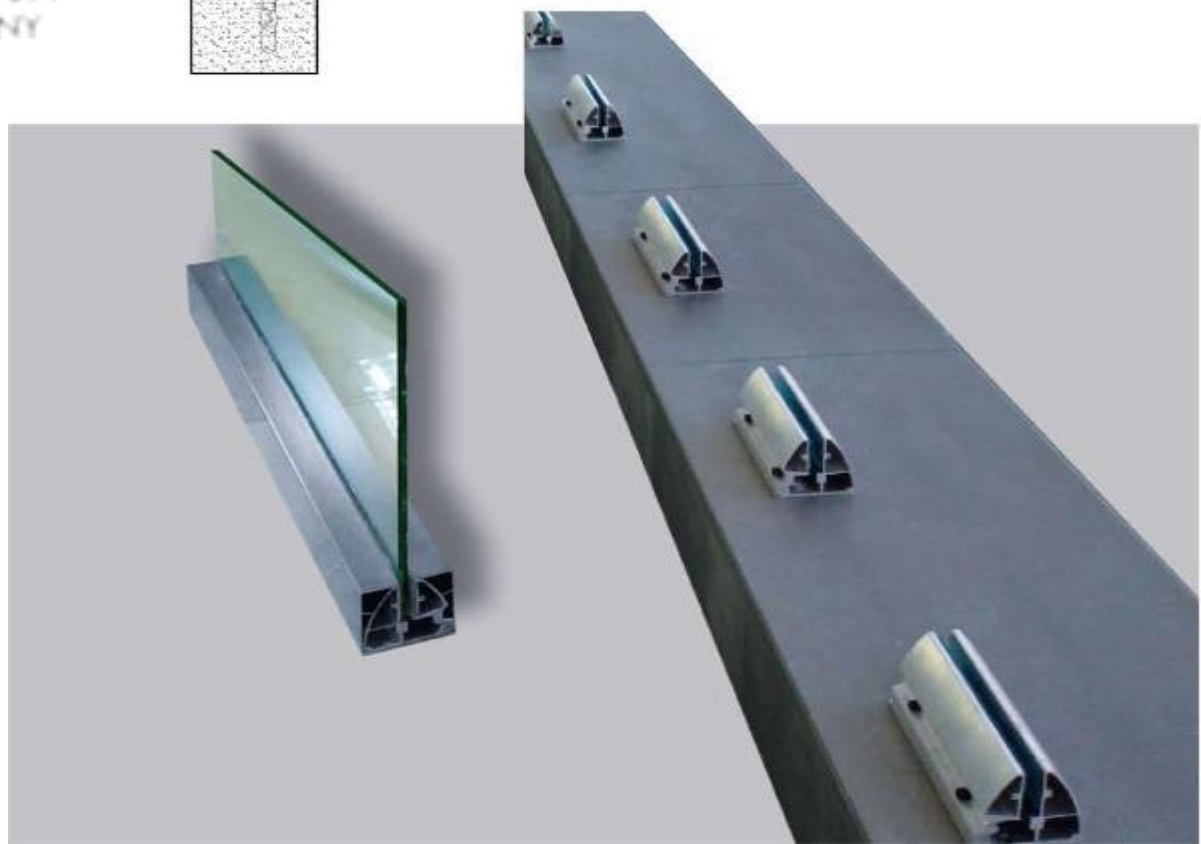



PESPA 007
SQUARE SYSTEM RAILINGS











PEGA 36



TUBE RING \varnothing 16 MM

PEGA 37



GLASS FASTENER

PEGA 38



ARC GLASS FASTENER

PEGA 39



GLASS HOLDER

PEGA 41/1



WALL TAP \varnothing 50 MM

PEGA 42



WALL TAP \varnothing 40 MM

PEGA 43



WALL FIXING \varnothing 30 MM

PEGA 44



WALL TAP \varnothing 16 MM

PEGA 44/1



FASTENER \varnothing 16
WITH \varnothing 30 MM

PEGA 44/2



FASTENER \varnothing 16
ME \varnothing 40 MM

PEGA 46



WALL FIXING \varnothing 50 MM

PEGA 46/20



WALL FIXING \varnothing 50 MM





PEGA 53/3 & 53/4



BASE AND STAKE

PEGA 55



DOUBLE HEAD
DECORATIVE

PEGA 59



RAILING HEAD
Ø50 MM

PEGA 60



FILLED, LONG FOOT
Ø50 MM

PEGA 60/1



TUBE COUPLER
Ø50 MM

PEGA 60/2



TUBE COUPLER
Ø40 MM

PEGA 60/5



TUBE COUPLER
Ø16 MM

PEGA 600



BUKE TUBE Ø16 MM

PEGA 600/3



FILLED TUBE
Ø41 250 MM

PEGA 600/4



FILLED Ø41 150 MM

PEGA 600/5



FILLED TUBE Ø60 MM

PEGA 600/6



FILLED TUBE Ø41
MM SHORT



PEGA 601



**RAILING HEAD \varnothing 40 MM
WITH CHANNEL**

PEGA 64



**DECORATED BASE
WITH CHANNEL \varnothing 40 MM**

PEGA 66



**LONG BASE \varnothing 40 MM
WITH CHANNEL**

PEGA 68



MURAL HEAD

PEGA 69



MURAL HOLDER

PEGA 71



**FASTENER FOR TUBE
 \varnothing 40 MM FOR \varnothing 30 MM**

PEGA 71/1



TUBE \varnothing 30 MM FASTENER

PEGA 71/2



**TUBE \varnothing 30 MM FASTENER
WITH BRACKETS**

PEGA 71/4



**TUBE \varnothing 30 MM FASTENER
WITH DRILLS**

PEGA 711



**SIDE TUBE \varnothing 40 MM
FASTENER**

PEGA 712



**TUBE \varnothing 50 MM
FASTENER**

PEGA 714



**TUBE \varnothing 40 MM
HOLDER**



PEGA 717



**FASTENER FOR TUBE
TUBE Ø40 MM**

PEGA 718



**FASTENER FOR TUBE
Ø40 MM WITH Ø30 MM**

PEGA 720



**FASTENER FOR TUBE
Ø41 MM WITH Ø60 MM**

PEGA 721



**FASTENER FOR TUBE
Ø40 MM WITH Ø50 MM**

PEGA 722



**FASTENER FOR TUBE
Ø41 MM WITH Ø50 MM**

PEGA 723



**FASTENER FOR TUBE
Ø40 MM WITH Ø40 MM**

PEGA 76



**GASKET FOR
MURAL FASTENER**

PEGA 77



**THICKNESS ADOPTED
FOR MURAL FASTENER**

PEGA 81



**FOOT Ø40 MM,
TUBE STAKE, NORMAL**

PEGA 811



SHORT STAKE

PEGA 82



**STAKES WITH
SLICES Ø40 MM**

PEGA 84



STAKES Ø30 MM



PEGA 87



STAKE FOR $\varnothing 40$ MM
LONG 33 CM

PEGA 97



INGOT HOLDER
WITH HOLE $\varnothing 16$ MM

PEGA 99



T GLASS FASTENER

PEGA 100



I GLASS FASTENER

PEGA 10/3



SPECIAL BASEMENT
FOR $\varnothing 40$ MM

PEGA 101/102



GLASS HOLDER

PEGA 135



FASTENER $\varnothing 50$ MM RING

PEGA 105/106



TUBE FASTENER
 $\varnothing 40$ MM SIDE

PEGA 104



TUBE HOLDER
 $\varnothing 50$ MM MURAL

PEGA 132



GLASS SPIDER
(WHOLE KIT)

PEGA 180/181



CENTRAL GLASS
FASTENER

PEGA 182/183



SIDE GLASS FASTENER



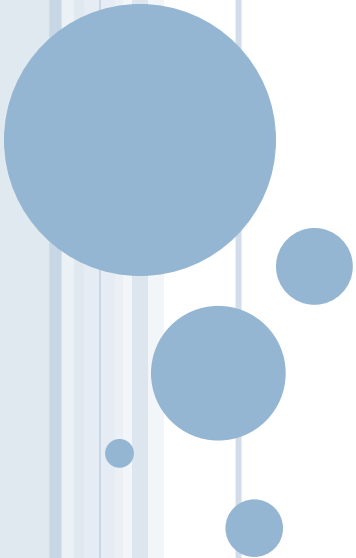

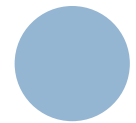
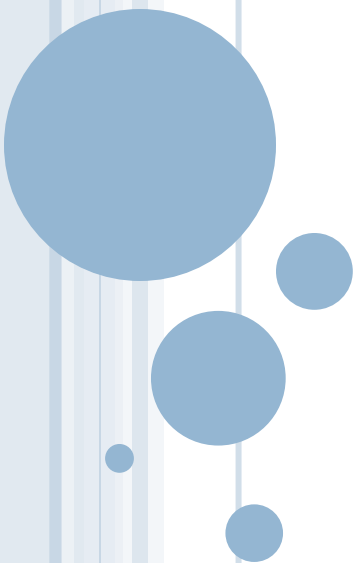

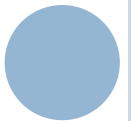
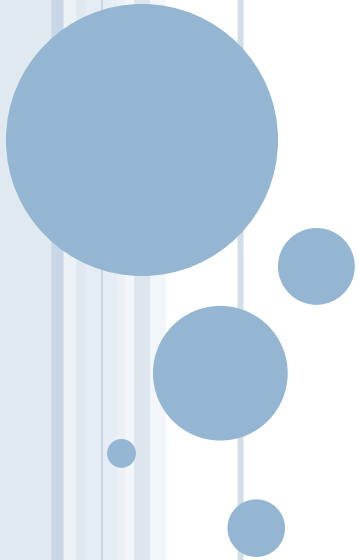

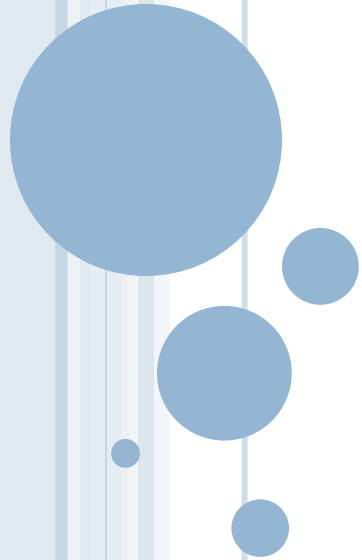

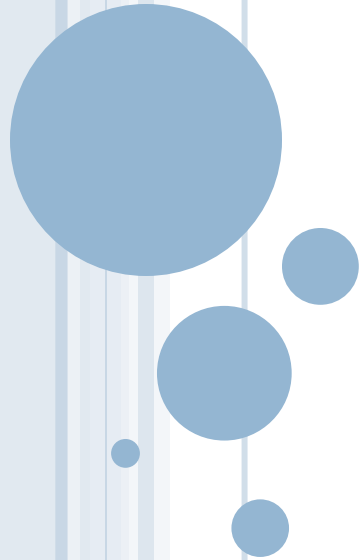

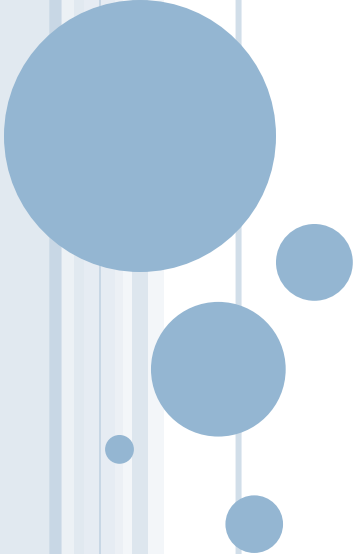

PROJECTS REALIZED IN TIRANA

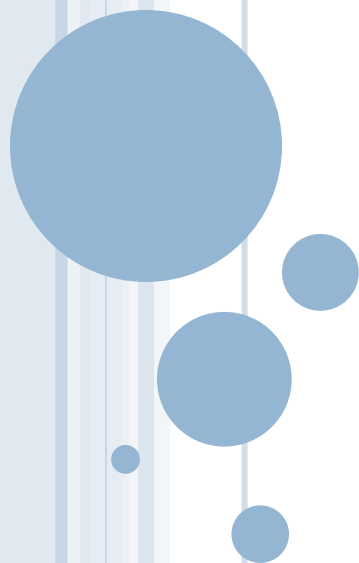

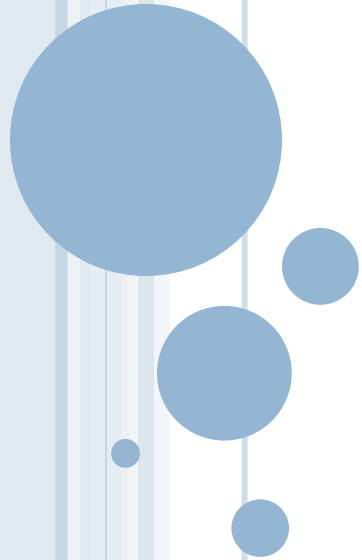



PROJECTS REALIZED IN VLORA





PROJECTS REALIZED IN ITALY

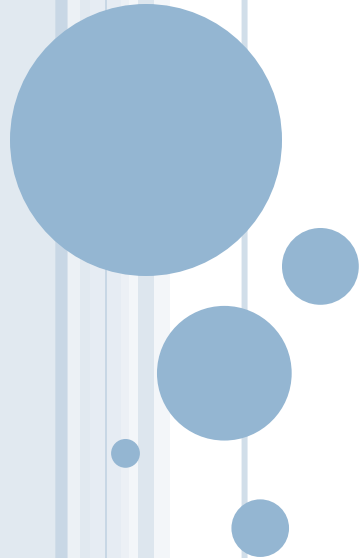

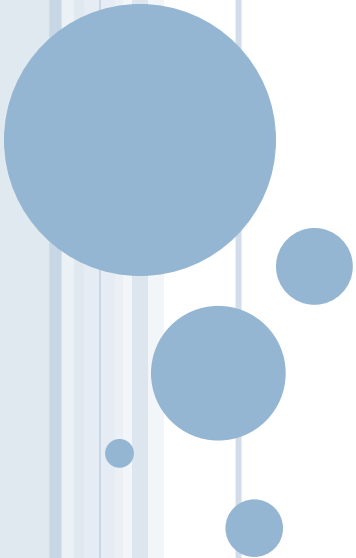

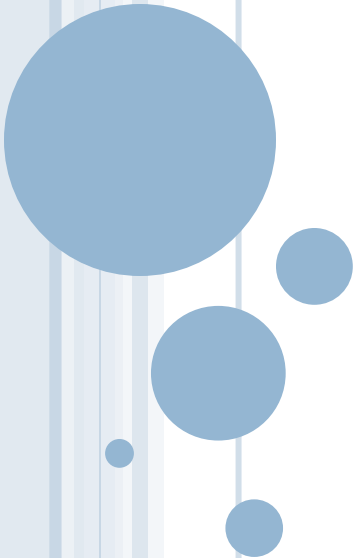

Certificates

www.noblesse-company.com



The collage displays several certification documents:

- Top Left:** A purple document with a grid pattern, titled "DOCUMENTO - Dichiarazione" from Istituto Giordano.
- Top Middle:** A document from Istituto Giordano titled "BREVETTO DI INDIRIZZO 2016" for the course "CORSO DI FORMAZIONE PER IL PERSONALE TECNICO E AMMINISTRATIVO".
- Top Right:** A document from Istituto Giordano titled "BREVETTO DI INDIRIZZO 2016" for the course "CORSO DI FORMAZIONE PER IL PERSONALE TECNICO E AMMINISTRATIVO".
- Middle Left:** A document from Istituto Giordano titled "BREVETTO DI INDIRIZZO 2016" for the course "CORSO DI FORMAZIONE PER IL PERSONALE TECNICO E AMMINISTRATIVO".
- Middle Middle:** A document from Istituto Giordano titled "BREVETTO DI INDIRIZZO 2016" for the course "CORSO DI FORMAZIONE PER IL PERSONALE TECNICO E AMMINISTRATIVO".
- Middle Right:** A document from Istituto Giordano titled "BREVETTO DI INDIRIZZO 2016" for the course "CORSO DI FORMAZIONE PER IL PERSONALE TECNICO E AMMINISTRATIVO".
- Bottom Left:** An IONet certificate for "FIDSA & ALUMINIUM ALUMINIUM" issued on 20/09/2016.
- Bottom Right:** A RINA certificate for "FIDSA & ALUMINIUM ALUMINIUM" issued on 20/09/2016.

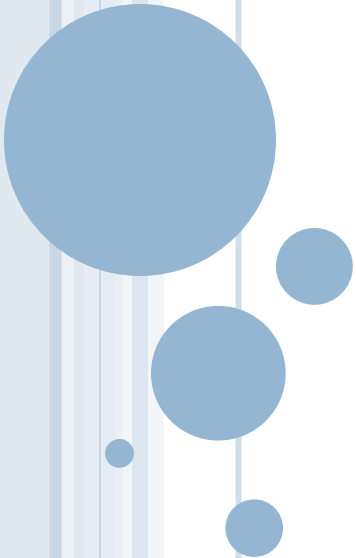



Garde corps

www.noblesse-company.com